

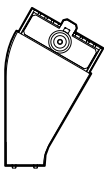













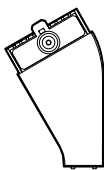

# Zugentlastung Faserkamm NR Strain Relief Block Retrofit Kit

## Lieferumfang | Scope of delivery

Ausrichtung Orientation	Befestigungskit Fixing kit	Ausführung Montageplatte Type of mounting plate	ArtNr. Part number	
	10x  20x +  20x	 mit Bohrung Ø 2,6 mm with hole Ø 2.6 mm	 mit Einpressgewinde M3 with screw thread M3	<b>59.2600.31.00E1</b>
1x	 2x	 mit Bohrung Ø 2,6 mm with hole Ø 2.6 mm		54.0306.13.00
1x	 2x	 mit Einpressgewinde M3 with screw thread M3		59.2600.31.00
	10x  20x +  20x	 mit Bohrung Ø 2,6 mm with hole Ø 2.6 mm	 mit Einpressgewinde M3 with screw thread M3	<b>59.2600.34.00E1</b>
1x	 2x	 mit Einpressgewinde M3 with screw thread M3		59.2600.34.00

 **Montagehinweise des Gehäuses beachten.**  
*Note the instructions of the cabinet.*

## Montage | Installation

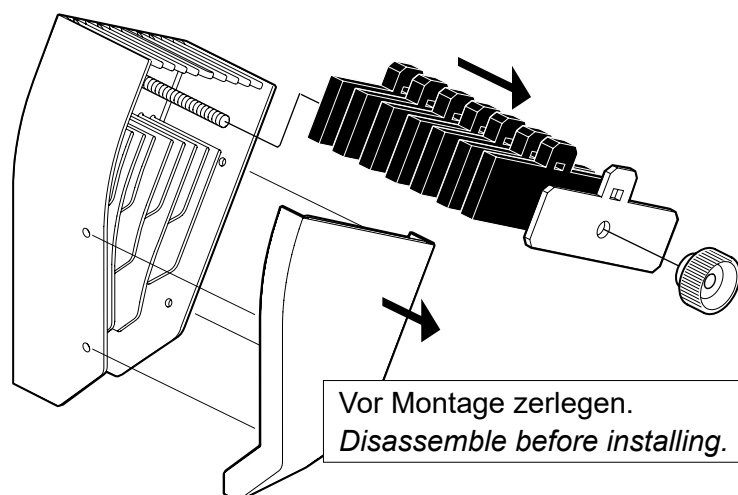

 **Demontage- und Entsorgungshinweis**  
*Disassembly and disposal information*

Baugruppen können vereinzelt und Materialien entsprechend Sorte separiert werden. Metall- und Kunststoffteile sortenrein und fachgerecht entsorgen. Bitte beachten Sie für alle Produkte die jeweils gültigen Entsorgungsrichtlinien.  
*Assemblies can be disassembled and materials can be sorted by type. Metal and synthetic parts should be unmixed and disposed of correctly. Please take special note of any regulations regarding the disposal of any products.*

